

HỆ KHUNG TRẦN CHÌM Concealed Ceiling System

MONO KHUNG TRẦN CHÌM PHỔ THÔNG Standard Concealed Ceiling System



PARA KHUNG TRẦN CHÌM CAO CẤP Advanced Concealed Ceiling System



GAMMA KHUNG TRẦN CHÌM CAO CẤP Advanced Concealed Ceiling System

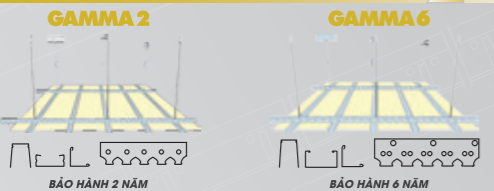

SUPER KHUNG TRẦN CHÌM CAO CẤP Advanced Concealed Ceiling System



HỆ KHUNG TRẦN NỔI Exposed Ceiling System

ALPHA KHUNG TRẦN NỔI Exposed Ceiling System

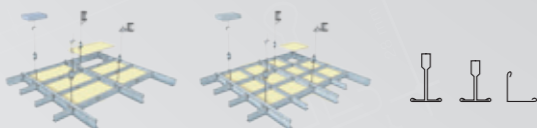

MEGA KHUNG TRẦN NỔI Exposed Ceiling System

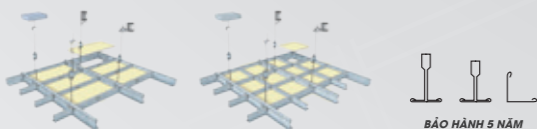

OMEGA KHUNG TRẦN NỔI SÓC ĐEN Tie System with Black Reveal

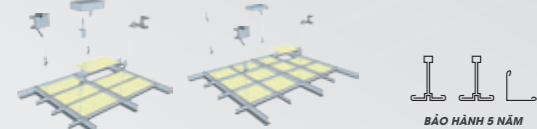

HỆ KHUNG VÁCH Drywall System

PARTI KHUNG VÁCH NGĂN PHỔ THÔNG Standard Drywall System

PARTI 64 - 76
Độ dày: 0.42 (mm)
Thickness: 0.42 (mm)



PARTI⁺ KHUNG VÁCH NGĂN CAO CẤP Advanced Drywall System

PARTI PLUS 64 - 76 - 92 - 102
Độ dày: 0.50 (mm)
Thickness: 0.50 (mm)



PARTI^{MAX} KHUNG VÁCH NGĂN CAO CẤP Advanced Drywall System

PARTI MAX 64 - 76 - 92 - 102 - 127 - 152
Độ dày: 0.75 / 1.00 / 1.15 (mm)
Thickness: 0.75 / 1.00 / 1.15 (mm)



TẤM TRẦN Ceiling Board

GYP ART TẤM THẠCH CAO MỸ THUẬT GypArt Board



DOMINO TRẦN KIM LOẠI Metal Ceiling



PHỤ KIỆN AAA Accessories

AAA CỬA THÂM TRẦN Access Panel

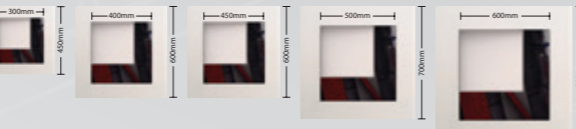

AAA BĂNG KEO LƯỚI Fiberglass Tape



AAA BĂNG KEO GIẤY Paper Tape



NHÀ MÁY SẢN XUẤT KHUNG TRẦN VÀ KHUNG VÁCH MANUFACTURER OF CEILING AND DRYWALL STEEL FRAME

D & S CORPORATION



www.dsceiling.com



KHUNG TRẦN CHÌM PHỔ THÔNG

MONO

Standard Concealed Ceiling System

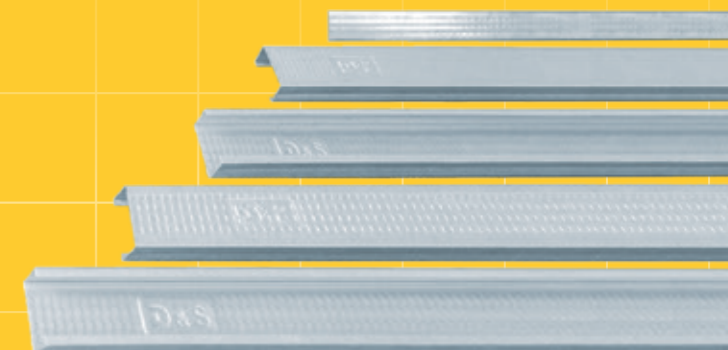

D & S CORPORATION



www.dsceiling.com

CÔNG TY CỔ PHẦN D&S

Chất Lượng
& AN TOÀN
Quality and Safety



CHI TIẾT KỸ THUẬT / DETAIL

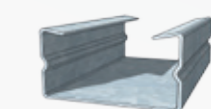
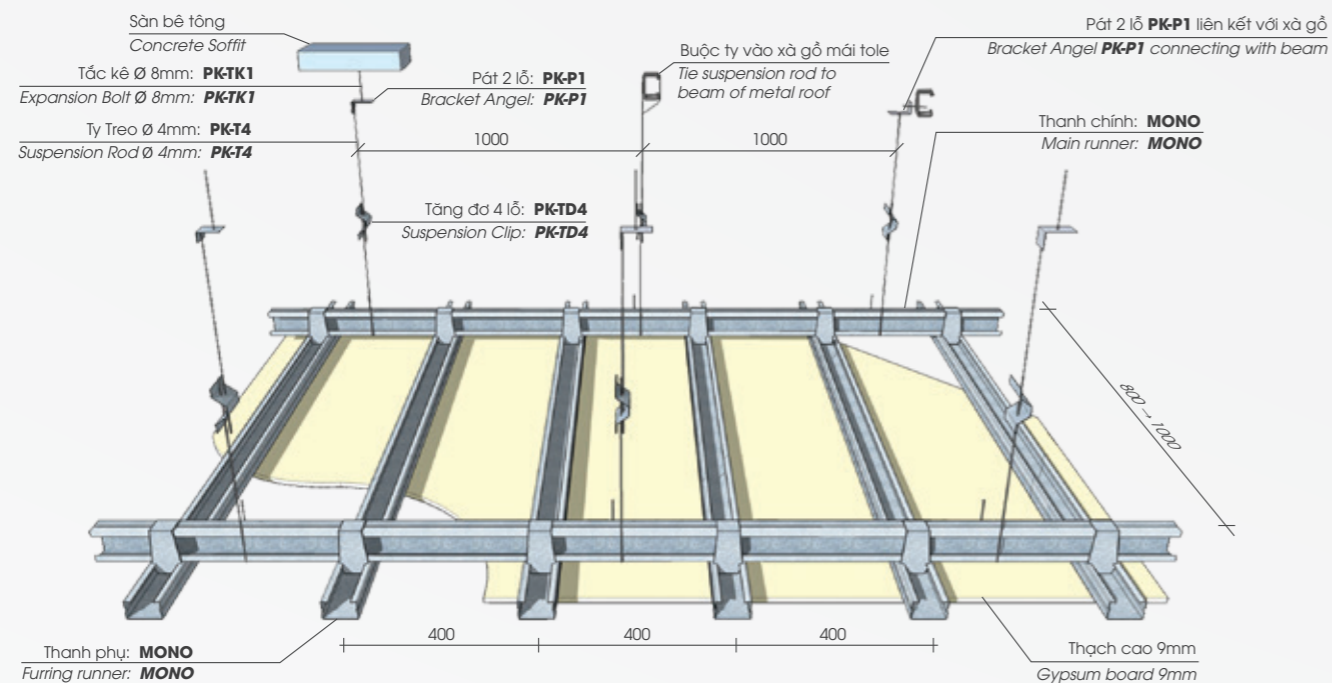

THANH CHÍNH: MONO
MAIN RUNNER: MONO
(14 x 35 x 4000)mm
Độ dày / Thickness:
MONO 1: 0.35 mm (± 0.02mm)
MONO 3: 0.32 mm (± 0.02mm)

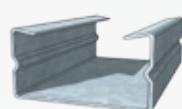

THANH PHỤ: MONO
FURRING RUNNER: MONO
(14 x 35 x 4000)mm
Độ dày / Thickness:
MONO 1: 0.35 mm (± 0.02mm)
MONO 3: 0.32 mm (± 0.02mm)

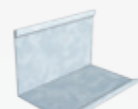

THANH GÓC: V
WALL ANGLE: V
(20 x 20 x 4000)mm
Độ dày / Thickness:
V - 1: 0.35 mm (± 0.02mm)
V - 3: 0.32 mm (± 0.02mm)



KHÓA LIÊN KẾT: PK-K1
CONNECT CLIP: PK-K1

HƯỚNG DẪN LẮP ĐẶT

- Bước 1:** Định vị cao độ trần.
- Bước 2:** Lắp thanh góc theo cao độ trần.
- Bước 3:** Treo ty vào sàn bê tông hoặc xà gỗ với khoảng cách ≤ 1000mm.
- Bước 4:** Lắp thanh chính vào ty treo.
- Bước 5:** Lắp thanh phụ vào thanh chính bằng khóa liên kết.
- Bước 6:** Điều chỉnh phẳng khung trần và lắp tấm. Khoảng cách vít ở biên tấm trần ≤ 200mm và giữa tấm trần là ≤ 300mm.
- Bước 7:** Dán băng keo lưới toàn bộ mối nối tấm trần.

INSTALLATION GUIDE

- Step 1:** Determine the height of the false ceiling.
- Step 2:** Install the wall angles at the height of the false ceiling.
- Step 3:** Hang the suspension rods from the concrete soffit or the beam, spacing ≤ 1000mm.
- Step 4:** Install the main runners connecting with the suspension rods.
- Step 5:** Install the furring runners connecting with the main runners using connect clips.
- Step 6:** Adjust the height of ceiling frame and fix boards onto frame. The spacing between screws at the borders ≤ 200mm; in the middle ≤ 300mm
- Step 7:** All joints to be applied with adhesive tapes.